

Single- unit
(Art.no. CSR.3x5-S)

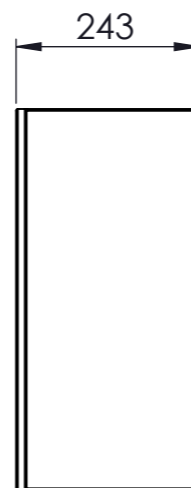
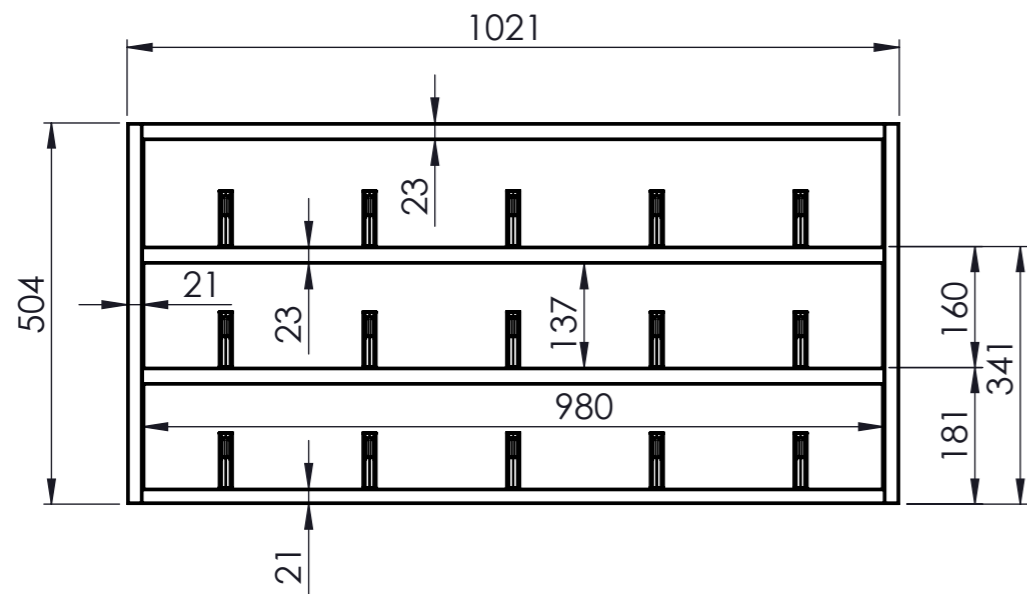
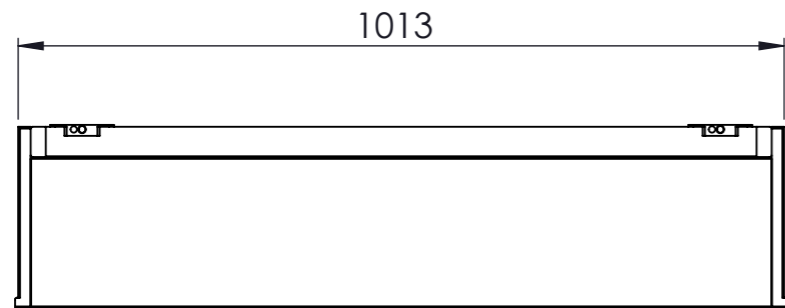
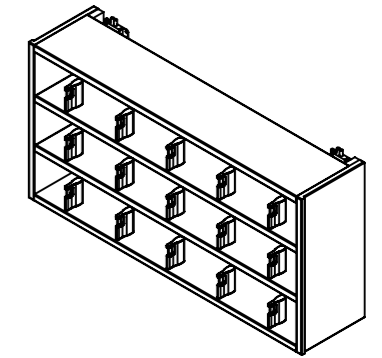

Les tailles affichées sont précises. Les détails sont des illustrations et peuvent être différents en réalité.
De weergegeven maten zijn waarheidsgetrouw, de details zijn ter illustratie en kunnen afwijken van de werkelijkheid.
The sizes shown are accurate, the details are for illustration purposes only and may look different in reality.
Die angegebenen Größen sind genau, die Angaben dienen nur zur Veranschaulichung und sehen in der Realität anders aus.

description: Carré Steel Shelves Lockable 3x5 Single		material: -		technical specifications: - tolerances according to: . - unless otherwise stated - debur and break sharp edges			
project: -		treatment: -					
client: -		finish: -					
<p>Top Vision Group BV Waarderweg 58, 2031 BP Haarlem The Netherlands T +31 (0)23 51 76 677 info@topvisiongroup.com</p>		all dimensions in:	size:	projection:	name:	date:	
		mm	A3		drawn:	GJE	20220111
		scale:1:10	sheet 1 of 3	third angle	checked:	-	-
		status: For information only			approved:	-	-
				drawing #:	revision:		
				CSR.3x5-S	-		

Left Couple- unit
(Art.no. CSR.3x5-L)

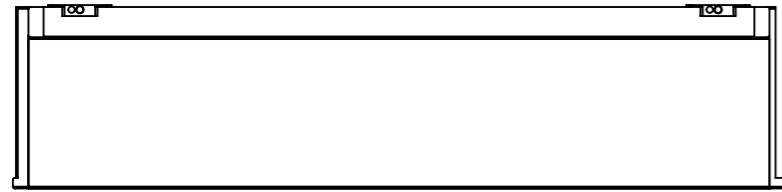

Centre Couple- unit
(Art.no. CSR.3x5-C)

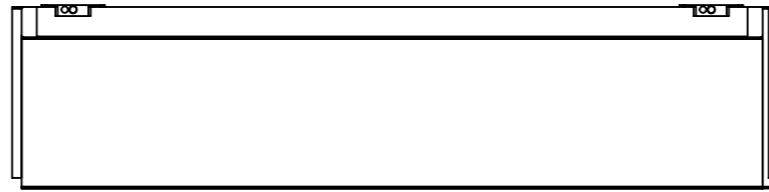

Right Couple- unit
(Art.no. CSR.3x5-R)

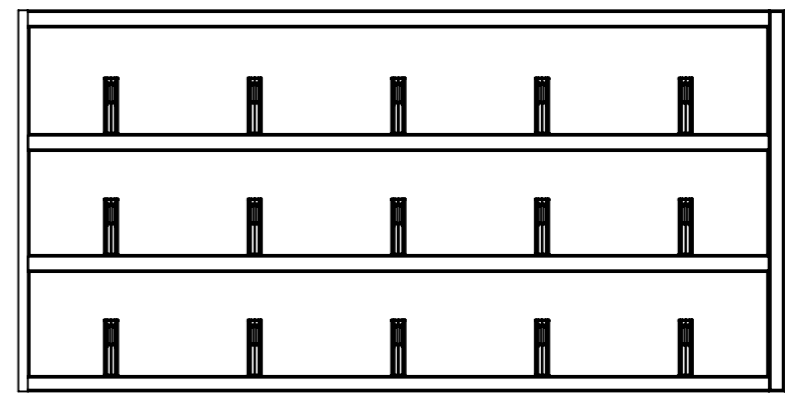
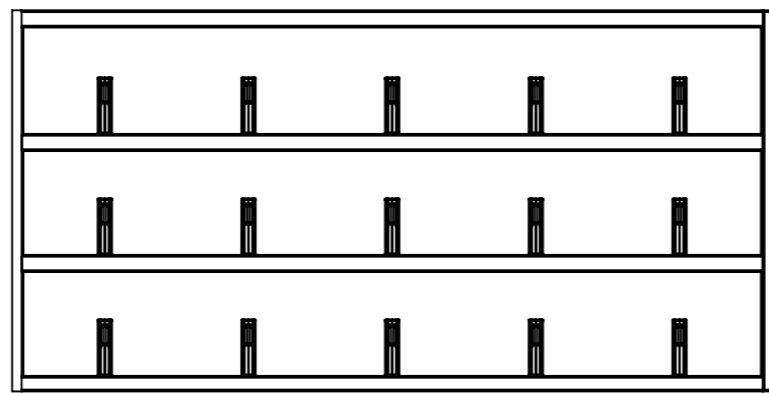
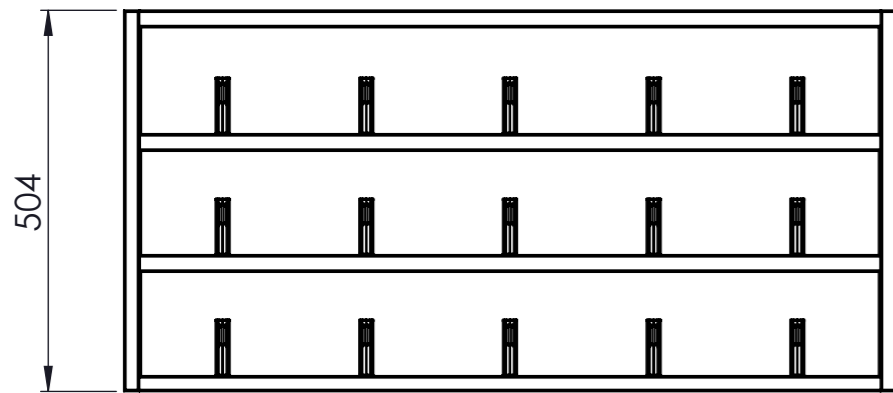
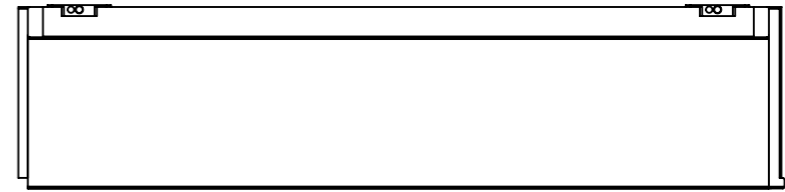

Les tailles affichées sont précises. Les détails sont des illustrations et peuvent être différents en réalité.
 De weergegeven maten zijn waarheidsgetrouw, de details zijn ter illustratie en kunnen afwijken van de werkelijkheid.
 The sizes shown are accurate, the details are for illustration purposes only and may look different in reality.
 Die angegebenen Größen sind genau, die Angaben dienen nur zur Veranschaulichung und sehen in der Realität anders aus.

description: Carré Steel Shelves Lockable 3x5 Couple Units		material: -		technical specifications: - tolerances according to: - unless otherwise stated - debur and break sharp edges		
project: -		treatment: -				
client: -		finish: -				
		all dimensions in:	size:	 third angle	name:	date:
		mm	A3		GJE	20220111
		scale: 1:10	sheet 2 of 3		checked:	-
		status: For information only			approved:	-
					drawing #:	revision:
					CSR.3x5-L-C-R	-

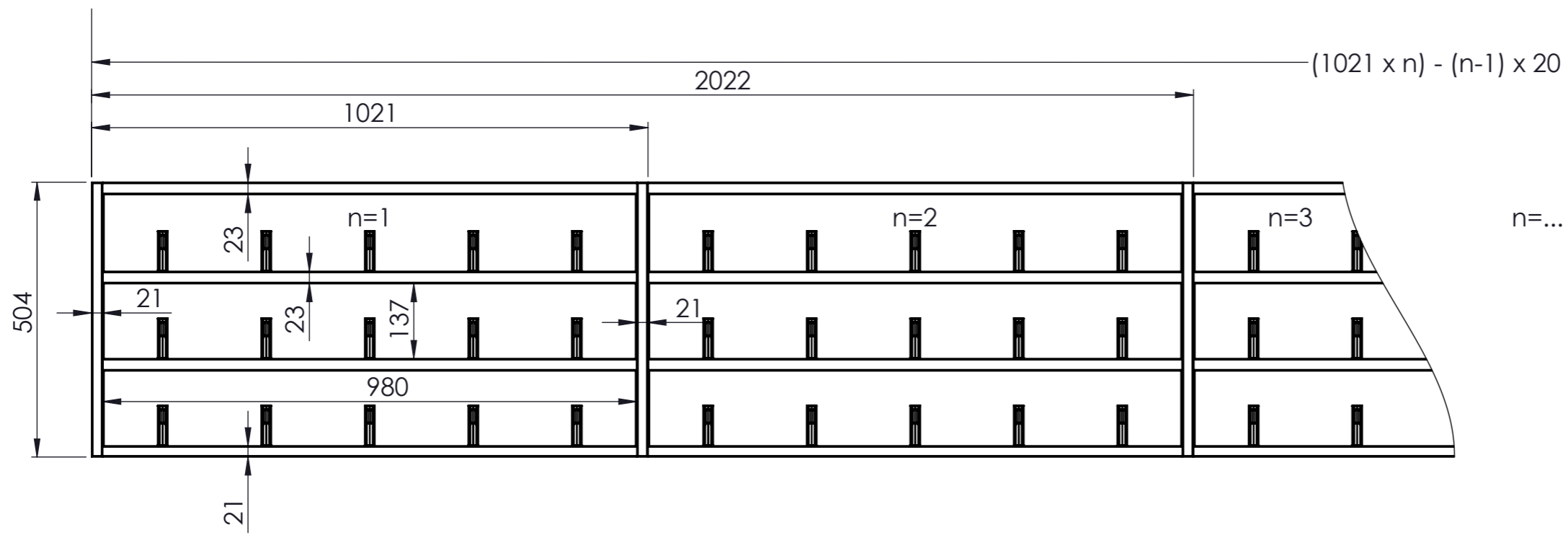
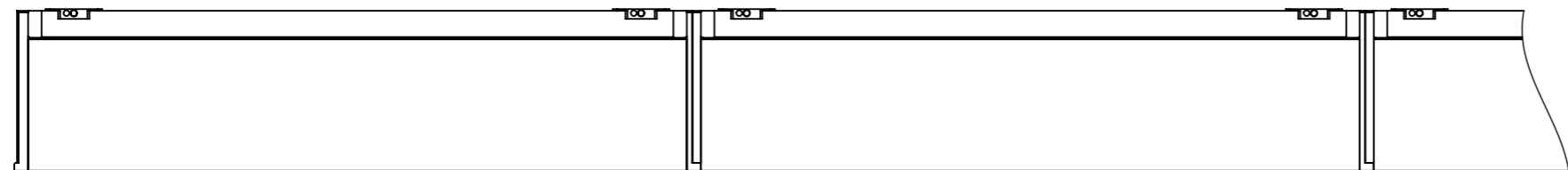

Les tailles affichées sont précises. Les détails sont des illustrations et peuvent être différents en réalité.
 De weergegeven maten zijn waarheidsgetrouw, de details zijn ter illustratie en kunnen afwijken van de werkelijkheid.
 The sizes shown are accurate, the details are for illustration purposes only and may look different in reality.
 Die angegebenen Größen sind genau, die Angaben dienen nur zur Veranschaulichung und sehen in der Realität anders aus.

description: Carré Steel Shelves Lockable 3x5 Coupled		material: -		technical specifications: - tolerances according to: . - unless otherwise stated - debur and break sharp edges	
project: -		treatment: -			
client: -		finish: -			
<p>Top Vision Group BV Waarderweg 58, 2031 BP Haarlem The Netherlands T +31 (0)23 51 76 677 info@topvisiongroup.com</p>		all dimensions in:	size:	projection:	
		mm	A3		name:
		scale:1:10	sheet 3 of 3	third angle	date:
		status: For information only			drawing #:
			CSR.3x5 Coupled	-	